

**WILLIAMS AV**

***AMPETRONIC***

**C Series  
Installation Handbook  
& User Guide**

[www.williamsav.com](http://www.williamsav.com)

[www.ampetronic.co](http://www.ampetronic.co)



# CONTENTS

|  |           |
|--|-----------|
| <b>1. Safety &amp; Box Contents</b> .....                      | <b>2</b>  |
| <b>2. Introduction</b> .....                                   | <b>3</b>  |
| <b>3. Installation</b> .....                                   | <b>4</b>  |
| Location .....   | 4         |
| Tools & Equipment .....  | 5         |
| System Requirements .....                                      | 5         |
| <b>4. Quick Start Guide</b> .....                              | <b>6</b>  |
| Operation .....  | 6         |
| Factory Settings .....   | 6         |
| Control Interfaces .....                                       | 6         |
| Start Up Tests .....   | 7         |
| Initial Setting Up .....                                       | 7         |
| <b>5. Block Diagram</b> .....                                  | <b>7</b>  |
| <b>6. Features Overview</b> .....                              | <b>8</b>  |
| <b>7. Front Panel Menu Guide</b> .....                         | <b>10</b> |
| Menu Structure .....   | 10        |
| Home Screen .....  | 10        |
| Mode Screens .....   | 10        |
| Input Attenuation .....  | 12        |
| Loop Current .....   | 12        |
| Current Offset .....   | 13        |
| Metal Loss .....   | 13        |
| Test Signals .....   | 14        |
| Status .....   | 14        |
| Settings .....   | 14        |
| Additional Features .....                                      | 15        |
| <b>8. Ethernet Interface (optional)</b> .....                  | <b>16</b> |
| Audio Settings Tab .....                                       | 17        |
| Network Config Tab .....                                       | 19        |
| Status Tab .....   | 21        |
| <b>9. Email Notifications</b> .....                            | <b>22</b> |
| <b>10. Using a Wireless Router</b> .....                       | <b>23</b> |
| Using the Core Series Drivers with a TP-Link Nano Router ..... | 23        |
| Wireless Network Troubleshooting .....                         | 24        |
| <b>11. Telnet Commands</b> .....                               | <b>25</b> |
| <b>12. Troubleshooting</b> .....                               | <b>27</b> |
| <b>13. Updating Firmware &amp; Web Interface</b> .....         | <b>30</b> |
| <b>14. Accessories</b> .....                                   | <b>30</b> |
| <b>15. Technical Specifications to IEC 62489-1</b> .....       | <b>31</b> |
| <b>16. Glossary of Terms</b> .....                             | <b>33</b> |
| <b>17. Warranty</b> .....                                      | <b>35</b> |

## Box Contents

- 1 x C Series Driver including:
  - 1 x Loop connectors (2x for C5-2, C7-2)
  - 1 x DC connector
  - 2 x Input connectors
  - 1 x 100V line connector
  - 1 x Line out connector
  - 2 x 2mm steel 1U rack mount brackets
- Also includes:
  - 1 x C Series quick start guide
  - 1 x Power cable (region specific)
  - 1 x Induction Loop Sign
  - 4 x Self adhesive feet







**This symbol is used to alert the user to important operating or maintenance instructions.**



**The Lightning bolt triangle is used to alert the user to the risk of electric shock.**

## 1. SAFETY

1. It is important to read these instructions, and to follow them.
2. Keep this instruction manual in an accessible place.
3. Clean only with a dry cloth. Cleaning fluids may affect the equipment.
4.  Do not block any ventilation openings. Install in accordance with the manufacturer's instructions.
5. Do not install this equipment near any heat sources such as radiators, heating vents or other apparatus that produces heat.
6.  **WARNING – THIS APPARATUS MUST BE EARTHED / GROUNDED.**
7. Only power cords with the correct power connector may be used to maintain safety. Cables incorporating the UK 13A fused plug, Schuko with earthing contacts and UL approved “grounding type” are acceptable. These must be plugged into power outlets which provide a protective earth.
8. Refer all servicing to qualified personnel. Servicing is required when the apparatus has been damaged in any way, such as a power supply cord or plug is damaged, liquid has been spilled or objects have fallen into the apparatus, the apparatus has been exposed to any rain or moisture, does not operate normally or has been dropped.
9.  **WARNING – To reduce the risk of fire or electric shock, do not expose this apparatus to rain or moisture. The apparatus shall not be exposed to dripping or splashing and no objects filled with liquids, such as vases, shall be placed on the apparatus.**
10.  **Warning: Connection to a 100V line system may involve the risk of electric shock and therefore must be carried out by an instructed or skilled person.**



**TO PREVENT ELECTRIC SHOCK DO NOT REMOVE THE COVER. THERE ARE NO USER SERVICEABLE PARTS INSIDE. REFER SERVICING TO QUALIFIED PERSONNEL**

## 2. Introduction

The C Series hearing loop driver range has been designed as high quality digital, networkable single and dual loop output drivers. The range includes models intended for use with perimeter loops and multiple loop (MultiLoop™ / Phased Array) loop designs, and/or where the facility to control or access the unit via a network is required.

An Array System provides a solution where a simple loop around the room perimeter will not work. Arrays are the standard solution for buildings with metal structures or reinforcements, or for covering large areas. Arrays can also dramatically decrease the 'spill' of the magnetic signal outside of the room, allowing hearing loops to be installed in adjacent rooms, and providing an improved level of confidentiality. Arrays can also be used to change the way two loops interfere with each other, providing ways of solving even the most complex installation problems.

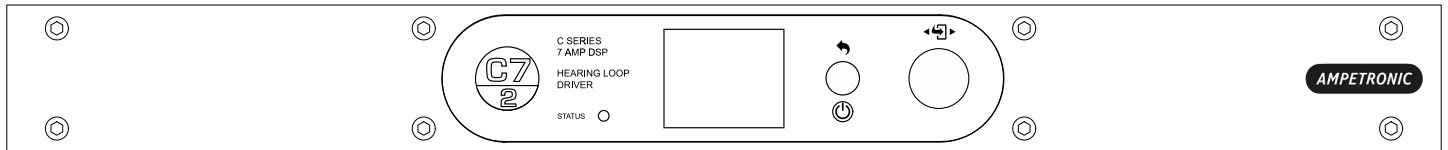

Depending on a number of factors regarding the installation of the loop and the set-up of the driver, the Core Series can provide compliance with EN 60118-4 for perimeter loop areas of up to 2 x 675m<sup>2</sup> or phased array systems up to 1,100m<sup>2</sup>.

Ease of installation, set-up and operation have been major factors in the design, combined with optimised performance and the freedom from R.F.I. generation.

The output channels on network equipped C Series models can be configured to be shifted in phase by 90°, or in phase with each other, allowing the use of array systems or two separate loops with the same signal, potentially doubling the area coverage.

The C Series drivers have two balanced inputs. These can be configured for microphone or line-level operation. Input 2 can also be used for 100V line operation.

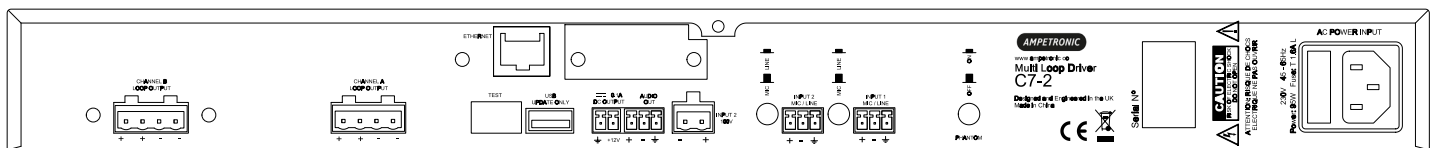

For more complex installations, you may need ancillary equipment such as microphone pre-amp(s), adaptor(s), or signal processing units. See Accessories or contact Ampetronic for advice.

The C Series range utilises class 'D' drivers; meaning a 60%+ increase in energy efficiency over previous solutions. Drivers feature a graphical user interface with intuitive menus, built in test signals, and precise audio level adjustments. Networked models are capable of remote control and monitoring, via email, a browser-based control panel, or standard networking protocols.

All units feature high power outputs plus ample voltage headroom, making them the most flexible solution on the market and suitable for a huge range of applications.

In another first for high-power Class D Induction Loop drivers, installation can be performed with total confidence, as unique multi-stage filtering ensures compatibility with both other system equipment and global EMC regulations. Networked C Series models also boast dual-slope metal loss compensation that caters for a wide range of metal loss frequency characteristics.

### 3. INSTALLATION

The following is a quick guide to installing and setting up the driver: All you need is an AC power source, a signal source, and a suitable loop layout. Guidance is available from the Ampetronic website or by contacting Ampetronic support.

#### Location

The unit may be free standing or 19" rack mountable using the rack 'ears' fitted.



The location must provide adequate ventilation for the unit.

Contact Ampetronic for advice on cooling requirements for your installation.

- a. Insert the driver into the 19" rack unit space and secure to the rails using suitable screws and washers.



- b. Affix loop feed cables (which may consist of a twisted pair or star-quad configured 4-core cable) to loop connectors (supplied) and insert into Output Channel A/B socket(s) on the rear of the driver. See Ampetronic Feed Cable Application Notes for further guidance.

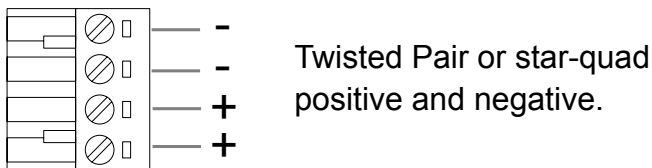

- c. Connect the signal inputs appropriately:

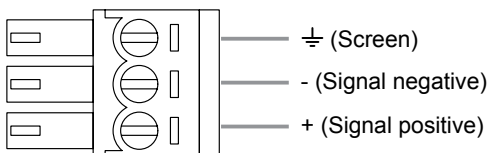

Microphones: Suitable dynamic or condenser microphone with balanced cable feed. Select phantom power as required. Connect to INPUT 1 and INPUT 2 (with selector switches in the appropriate position) using a 3-pole plug wired as per Connections drawing.

Line level signals: From other audio equipment such as PA system, mixing desk or CD player. Connect to INPUT 1 and INPUT 2 (with selector switches in the appropriate position) using a 3-pole plug wired as per Connections drawing. You may use either or both inputs.



Do not run input and output cables close together

- d. Connect AC power. See points 6 and 7 in SAFETY section.

**N.B. Do not switch the unit on until the loop outputs and signal inputs have been properly connected.**

## **Tools and Equipment**

Small hand tools including a wire stripper, small flat blade and pozi screwdrivers will be required.

A magnetic field strength meter, Loopworks Measure App & R1 Receiver, or at minimum an induction loop receiver is vital to check that the loop system is providing the desired level of performance.

## **System Requirements**

The induction loop cables are to be installed as per specific design instructions provided by Ampetronic, where appropriate.

In order to achieve correct operation it is recommended the loop and feed resistance should be between 0.2 and 10 $\Omega$  (at DC). Values outside this may cause the Error LED to illuminate at start up and the drivers output to be disabled or derated. Loop and feed impedance (at 1.6KHz) should be less than the voltage capability of the driver divided by the target current required to achieve field strength. Values above this figure may cause the CLIP indicator to illuminate. See troubleshooting section for advice on how to correct this and get your system working.

The Ampetronic website and support team provide more details on loop and feed cables. The correct design and positioning of the actual loop is vital for satisfactory system performance. If in doubt consult Ampetronic for advice.

# 4. QUICK START GUIDE

## Operation

If you are unfamiliar with Ampetronic C Series products please pay close attention to the setup procedure in order to take advantage of the advanced features that these drivers offer.

The C Series drivers analyse the loops that they are connected to at switch-on to check that they have the required characteristics. If the loop resistance exceeds 10Ω then a warning of high loop resistance is displayed.

The driver has two inputs labelled 1 and 2. Both inputs can be set to mic or line mode. 24V phantom power is available in mic mode. Additionally input 2 has a 100V input accessed through a separate 2 pin socket. **Do not use both input 2 sockets at the same time.**



Warning: Connection to a 100V line system may involve the risk of electric shock and therefore must be carried out by an instructed or skilled person.

Depending on the model, the driver has one or two loop outputs labelled Loop A and Loop B respectively.

## Factory Settings

From the factory the drivers are provided with the following setting:

|                                      |                        |
|--------------------------------------|------------------------|
| <b>Current:</b>                      | -20dB from full output |
| <b>Metal Loss Compensation (MLC)</b> | OFF                    |
| <b>Input Gain Channel 1</b>          | -80.0                  |
| <b>Input Gain Channel 2</b>          | -80.0                  |
| <b>Driver Name</b>                   | “Name not set”         |
| <b>Phase Shift</b>                   | ON                     |
| <b>Ethernet Parameters</b>           | Set by DHCP            |

The C Series drivers have their adjustments set in decibels (dB). A setting of 0dB equates to maximum current or to maximum input gain. A value of less than 0dB will reduce the current or input gain accordingly. This change is to simplify adjusting the driver output to meet the international performance Standard.

If the loop output is measured to be 2.7dB below the required level then adding 2.7dB to the current output should bring it to the Standard.

You can reset the driver to these factory default values from the user interface.

## Control Interfaces

The C Series drivers have two user control interfaces.

- 1. Graphical user interface on the unit front panel**
- 2. Browser Interface available via a network connection - where fitted**

The front panel controls and LCD display implement a simple menu system on the front of the driver whilst the Ethernet interface allows control through a web browser on a remote device. Additional control features are available on network versions.



## Start Up Tests

When C Series drivers are switched on they execute a series of tests that check the driver's internal systems and also the loops that they are connected to. These tests take about 5 seconds and the display reads "DIAGNOSTICS IN PROGRESS" whilst they are being performed.

If everything is OK the Home screen should be displayed. If an error was detected then the error light will flash red and the display will read the cause of the error. Please refer to section 10 where the error messages are explained in detail.

## Initial Setting up

C Series drivers include a test signal generator that can produce 6 different test signals:

- Sine Wave
- Pink Noise
- Sine Wave / Pink Noise Combi signals with 1 kHz, 1.6 kHz and 2.5 kHz Sine options
- Loop Output(s) Disabled mode

These signals over-ride the inputs on the back of the driver.

N.B. This driver is not stereo in that input 1 does not drive loop A and input 2 drive loop B. The factory default settings of the driver have both input gains set to -80dB (effectively off).

## 5. BLOCK DIAGRAM

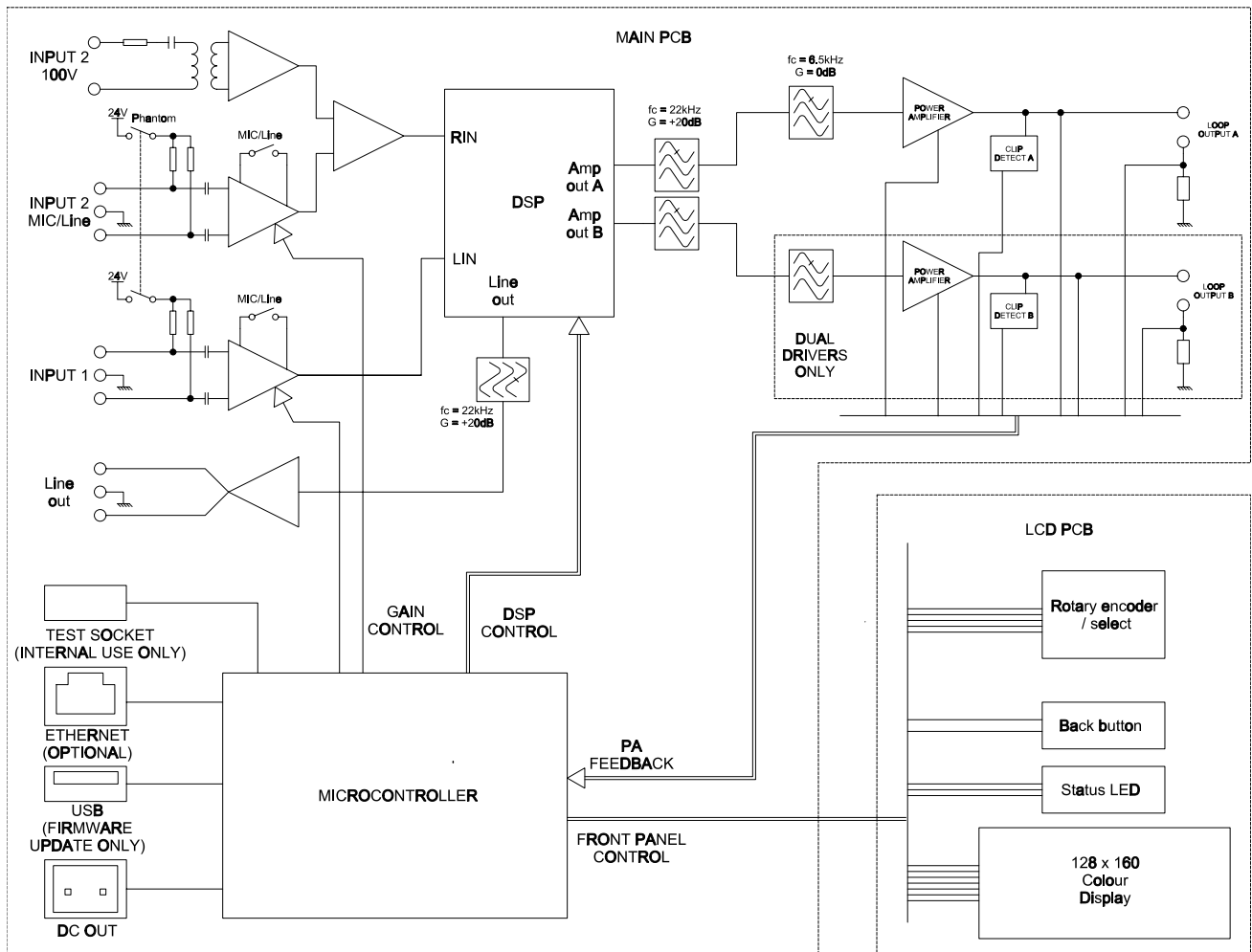

# 6. FEATURES OVERVIEW

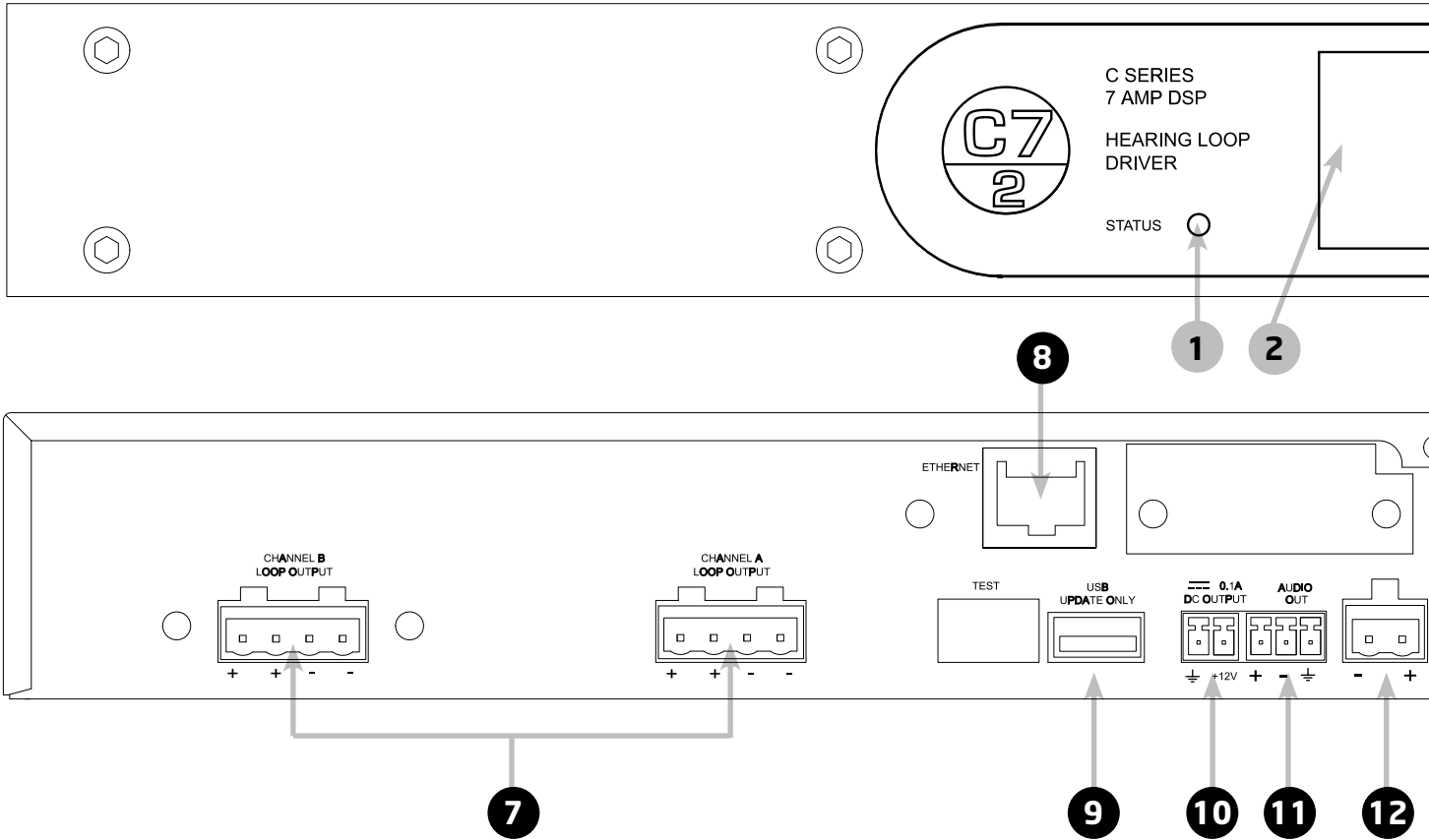

- 1 **STATUS LED:** Check the 'Status' menu for loop, amplifier and temperature errors and access fault codes to use when contacting Ampetronic. See troubleshooting for details.
- 2 **LCD DISPLAY SCREEN:** Displays amplifier model & configurable network name when idle, or menu selection and values during set-up and status checking.
- 3 **MENU NAVIGATION - HOME BACK & POWER:** Short press returns to the previous menu. Long press initiates power menu.
- 4 **MENU NAVIGATION - ROTATE:** moves between value screens or adjusts parameters
- 5 **MENU NAVIGATION - SELECT (PRESS):** select to enter menus

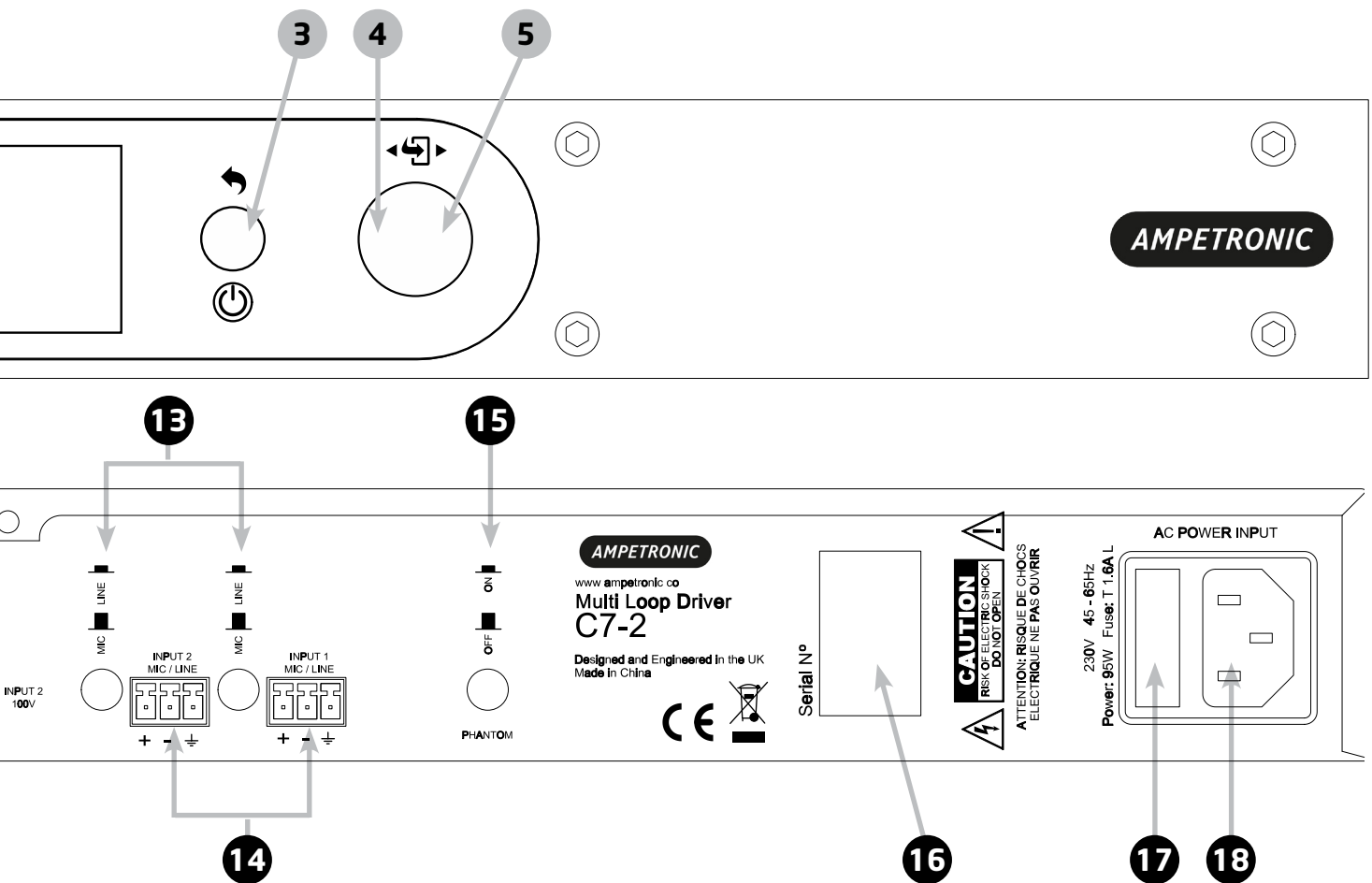

- 7 LOOP OUTPUT(S):** 4 way connections to loop cable(s).
- 8 ETHERNET:** For network cable (LAN or Wireless Router)
- 9 USB:** Use for Firmware upgrades or power for Wireless Router (200mA current limit)
- 10 DC OUTPUT:** 2-pin connection for ancillary units or status reporting (network option only)
- 11 LINE OUT:** A 3-pin 'pre-fade' balanced output to allow recording of the audio signal
- 12 100V LINE:** Additional input connected internally to input 2
- 13 MIC/LINE SWITCHES:** Push switches to set the input levels of input 1 or 2
- 14 INPUTS:** Socket for balanced MIC or LINE signals
- 15 PHANTOM SWITCH:** Phantom switch applies 24V to both inputs
- 16 SERIAL NUMBER:** For use when registering your warranty or reporting a fault.
- 17 FUSE:** Open to replace fuse (type dependent on driver model & supply voltage)
- 18 AC POWER:** Standard 3-pole IEC320 connector containing primary fuse for the unit.

# 7. FRONT PANEL MENU GUIDE

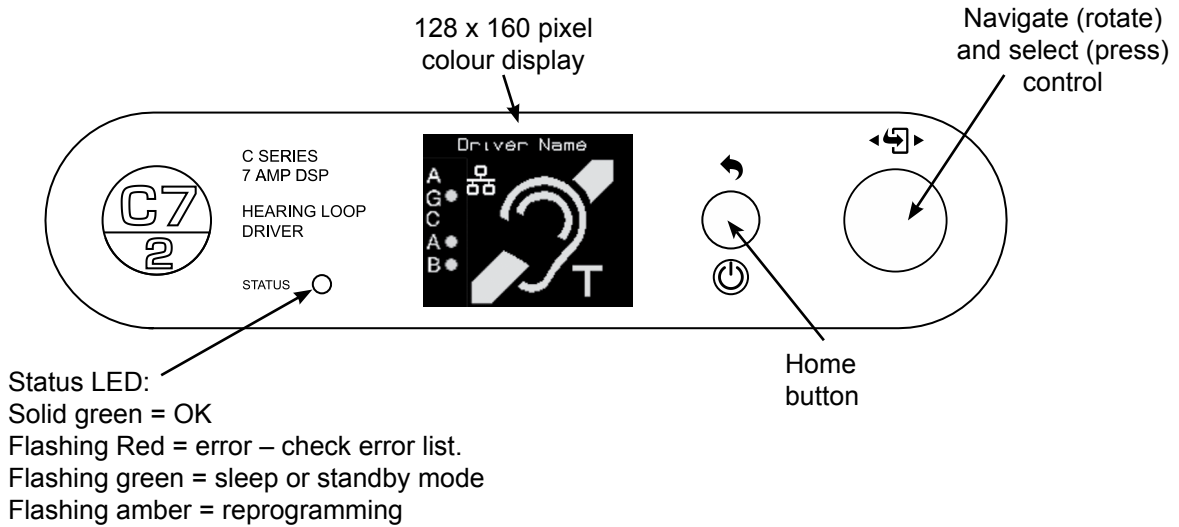

## Menu Structure

Once a unit is powered up and after the initial diagnostics the home screen appears. User interaction with any of the controls brings you to the first of 8 mode screens. Navigating then scrolls through these mode screens with wrap-around.

Clicking the home button will take you back to the home screen

Clicking the select control will take you into the value screen for the mode selected

## Home screen

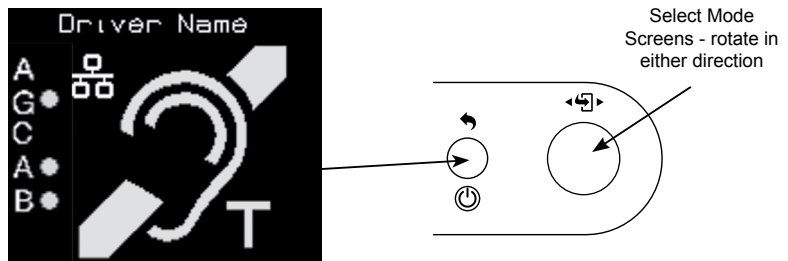

## Mode screens

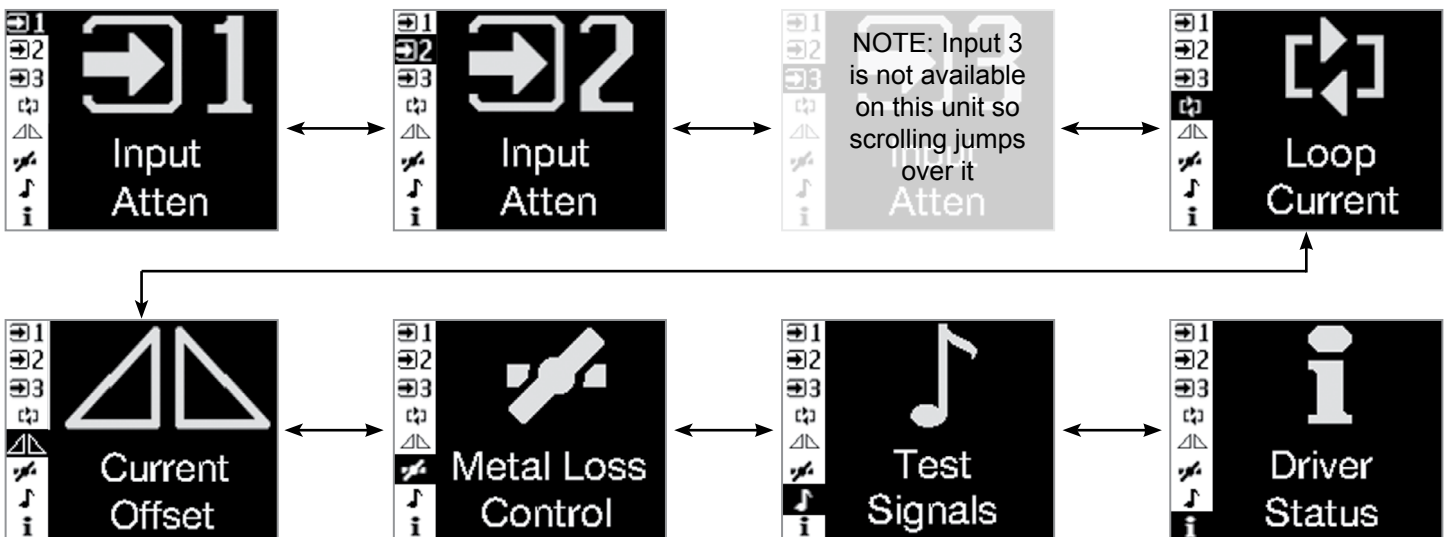

NOTE: MultiLoop™ models only

## Home screen display



**Driver name:**  
User defined field, defaults to model type i.e. C7-2N

**Ethernet logo:**  
Only present when Ethernet option is fitted.

**Side bar indicators AGC:**

- Yellow if AGC is active but not optimal.
- Green if optimal.
- Red if overloaded.

A & B: Shows current is present in loop outputs.

- Green if  $> -20\text{dB}$ ,
- Red if clipping

## Mode screen displays

Mode screens have a sidebar which shows all the available mode screens with the one selected shown in negative.

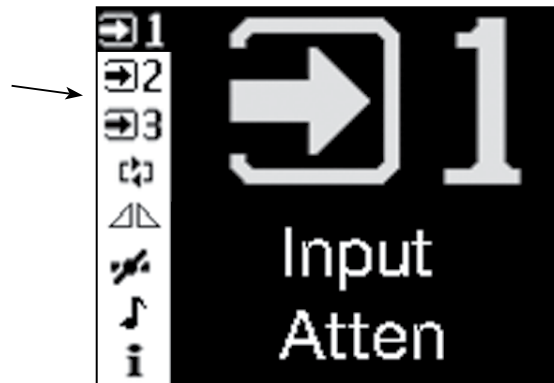

## Value screen displays

### Input Attenuation

**NOTE:**

All input attenuation value screens are the same so only this one is shown.  
All inputs can activate the AGC so the level shown may be due to a different input.

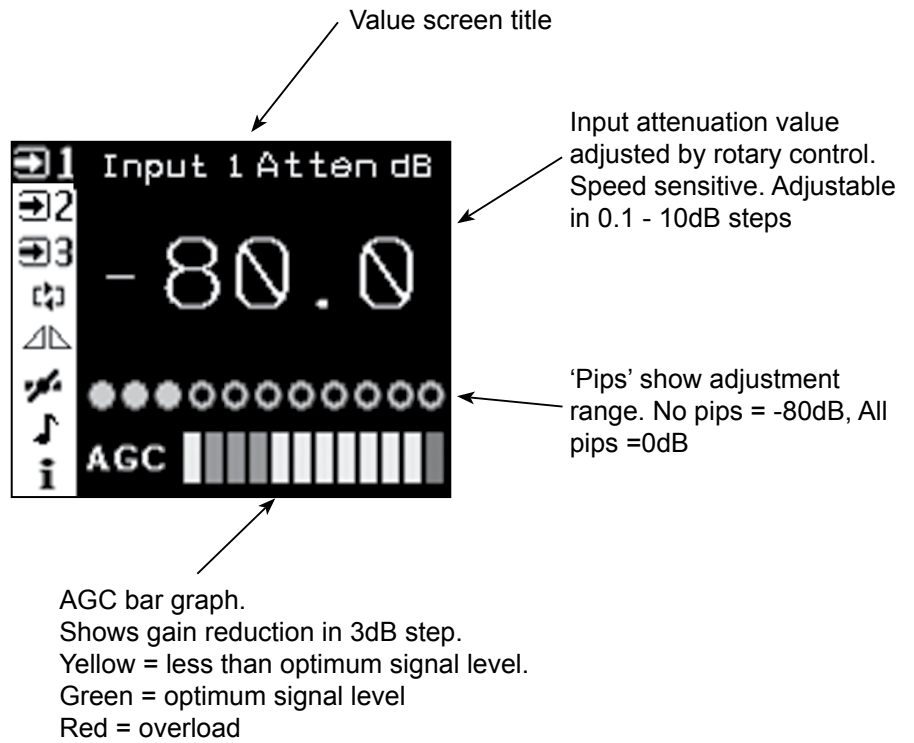

### Loop Current

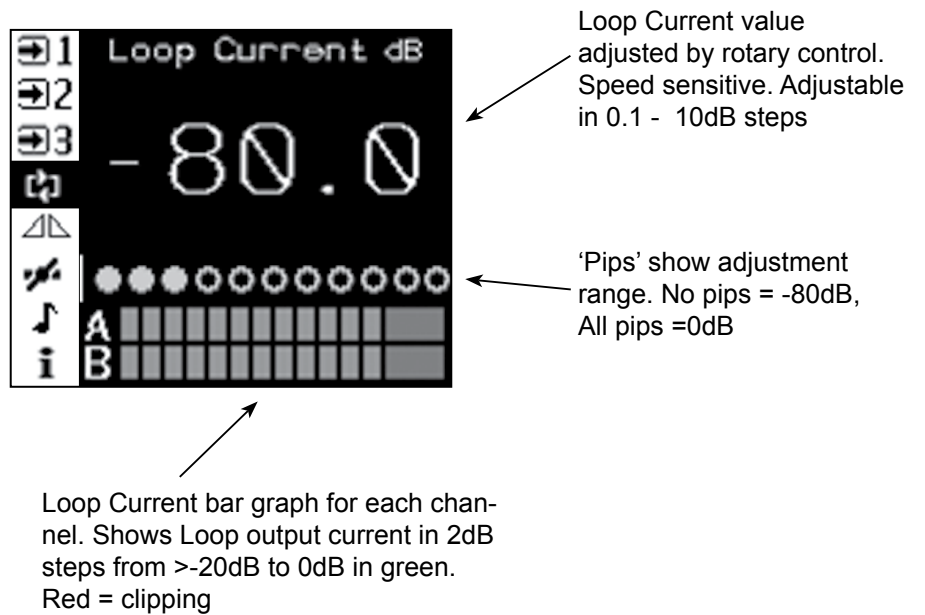

## Current Offset (MultiLoop™ models only)

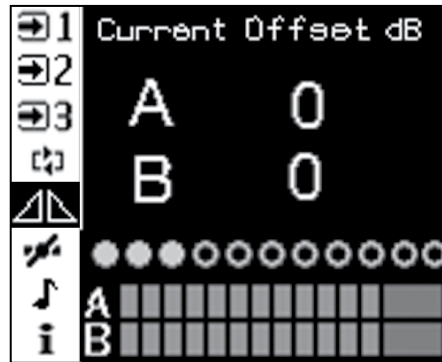

Current Offset value adjusted by rotary control. Counter clock-wise reduces channel A. Clock-wise reduces channel B. Adjustment is from 0 to -10dB on either channel. Further adjustment turns that channel off and disables loop test for that channel.

'Pips' show adjustment range. No pips = Loop A -10dB (Loop B = 0dB)

Centred = both channels 0dB

All pips = Loop B -10dB (Loop A = 0dB)

Loop Current bar graph for each channel. Shows Loop output current in 2dB steps from >-20dB to 0dB in green. Red = clipping

## Metal Loss

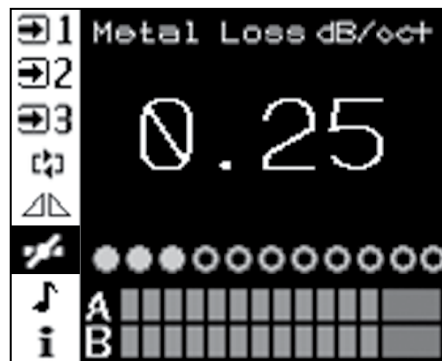

Metal Loss Correction value adjusted by rotary control. In 0.25dB steps from Off (0dB) to 4dB/Octave. Clockwise from 4dB/Octave sets MLC to 'Custom' – this is only configurable via the network connection (where fitted)

'Pips' show adjustment range. No pips = Off (0dB/oct)  
10 pips = 4dB/Oct  
11 pips = Custom

Loop Current bar graph for each channel. Shows Loop output current in 2dB steps from >-20dB to 0dB in green. Red = clipping

## Test signals

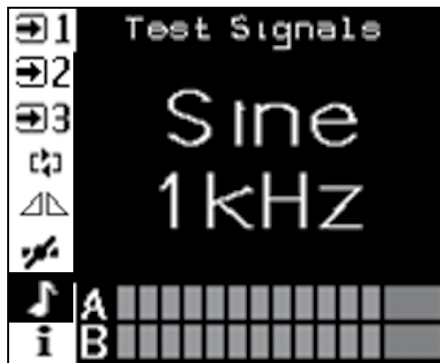

Test signal selected by rotary control:

- Off
- Pink noise
- Combi 1kHz, 1.6kHz & 2.5kHz
- Sine 100 – 5000Hz (3rd octave steps)
- Loop Output Disabled

All test signals timeout after 2 hours (default) this time can be changed in the website (on network versions).

Loop Current bar graph for each channel. Shows Loop output current in 2dB steps from >-20dB to 0dB in green. Red = clipping

## Status

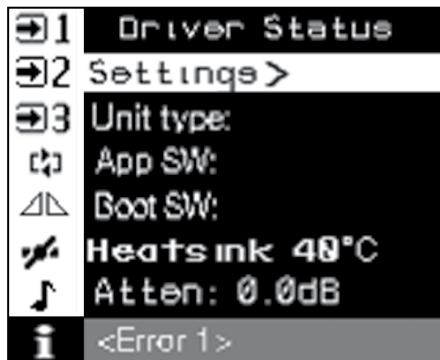

Status value screen contains mostly read only information.

Firmware version and unit type are shown. Heatsink and Atten show real-time values of the unit temperature and any output attenuation applied by power or temperature de-rating.

If there are errors and they go off the bottom of the screen a scroll bar appears showing that the screen can be scrolled using the rotary control.

Rarely used settings can be accessed by selecting the 'settings' sub-menu.

## Settings sub-menu



Network gives access to network settings and driver name.

Factory Reset allows the user to reset all the audio settings and the driver name to factory defaults.

System Re-start causes the driver to re-start without changing any settings. This could be to perform the start-up diagnostics again or to update the firmware (with a suitable USB stick connected)



## Additional features

**Home screen timeout** – if no action is taken in a mode screen after 30s the home screen is displayed. For a value screen the timeout is 60s.

**Sleep mode** – After a 10 minute period of user or audio inactivity the driver turns on the 'Loop outputs disabled' test signal and turns off the screen to save power. The Status led flashes green to indicate this. Any user activity or presence of audio signal brings the driver out of sleep. The inactivity time can be changed via the website (where fitted)

**Lock screen** – A long press on the home button brings up the lock menu. This gives access to standby, re-start (same as in settings menu) & lock. Selecting lock makes the user controls inactive. Any user input results in a padlock being displayed. To unlock the unit press the home button six times. Unlock instructions are shown briefly when lock is selected.

**Standby** – This is a user imposed sleep. Only user activity (not audio signal) brings the driver out of standby.

## 8. ETHERNET INTERFACE - Network versions only

Networkable C Series models feature a web interface that can be viewed in a web browser (optimised for the Chrome browser). The web interface is used to monitor and adjust the driver. You will be asked for the User Name and Password for the driver as a deterrent to unauthorised parties. These values are case sensitive and need to be entered once per session to access the driver.

**User Name = superadmin, netadmin, audioadmin**

**Password = ampetronic (default)**

Four levels of access are available:

1. superadmin - allows access to all settings
2. netadmin - access the network config page only
3. audioadmin - access the audio settings pages only
4. no login - allows access to status page only

### Setting up the Ethernet Interface

#### Ethernet infrastructure with DHCP server

The factory default setting is for Dynamic Host Configuration Protocol (DHCP) to be enabled. This allows the driver to request values for IP address, Gateway, Subnet Mask, and Primary and Secondary DNS from the host network DHCP server.

If an existing Ethernet IP system is available then the driver can be plugged into it and it will configure itself. When the driver obtains an IP address it will display it on the front panel LCD for 5 seconds.

To view the web interface type the IP address displayed into the web browser address bar on your device.

#### Ethernet infrastructure without DHCP server

If a DHCP server is not available, it is possible to enter manual values for the IP address, Subnet mask, DNS and Gateway from the front panel menu. Before you can do this, you will need to switch off DHCP.

After entering these values, the driver needs to be restarted again.

**Caution:** Manually setting the Ethernet values incorrectly can lead to problems on the Ethernet system and could potentially bring the network down.

#### Considerations for external network configuration

The C Series loop drivers communicate using a number of network port numbers. If you wish to communicate to/from the loop driver across a wider network (e.g. including routers, gateways, etc), you may need to ensure these ports are open for communication.

The web interface operates on the standard port 80. The email error message service sends through port 587. Port 80 is likely to already be open for outbound traffic but your network administrator may need to allow inbound connections to the loop driver on this port. 587 may be open but if you have problems you may need ask the administrator to allow outbound traffic to the internet (the loop driver will use 'SendGrid' to route all outbound email alerts).

## No Ethernet infrastructure available

A direct connection between the driver and a computer Ethernet is supported. Use a network cable to connect the loop driver and computer ethernet ports together, and wait a short while. Open a browser (Chrome is recommended) and enter the loop driver's IP address. This can be found using the front panel menu under Status / Settings / Network / IP address. It may take 30-60 seconds for an IP address to be negotiated. In some cases a power cycle may be required.

## Web Interface Structure

The Web interface is split into three tabs: Audio Settings, Network Config and Status. Clicking on the tab heading will change to the contents of that tab. There is also a link to a page which allows passwords to be updated.

The screenshot displays the web interface for the C7-ZN Hearing Loop Driver. The interface is titled "C7-ZN Hearing Loop Driver" and has three main tabs: "Status", "Audio Settings" (which is currently selected), and "Network Config".

Under the "Audio Settings" tab, there are two input sections:

- Input 1:** Features a dropdown menu for "Low cut filter" set to "off". Below it is a slider for "Attenuation (dB)" ranging from -80 to 0, with a current value of -10.4.
- Input 2:** Features a dropdown menu for "Low cut filter" set to "off". Below it is a slider for "Attenuation (dB)" ranging from -80 to 0, with a current value of -15.1.

Below the input sections is the "Test Signals" section, which includes three dropdown menus:

- Signal Type:** Set to "Sine wave".
- Frequency:** Set to "3.15 kHz".
- Timeout:** Set to "10 min".

The "Outputs" section contains two sliders:

- Current (dB):** Ranges from -80 to 0, with a current value of -12.
- Current Offset / Channel Off:** Ranges from OFF to OFF, with a current value of 0.

The "Metal-Loss Compensation" section has a dropdown menu for "Slope" set to "+0.25 dB/octave".

The "Output A & B Phase" section has a toggle switch for "90° Shift" set to "Off".

The "Power Saving Options" section includes:

- Sleep Mode (After No Signal):** Set to "10 min".
- Standby:** Set to "Off".

At the bottom of the interface, there are three horizontal sliders for "COMPRESSION (dB)", "CURRENT A (dB)", and "CURRENT B (dB)". The "COMPRESSION (dB)" slider ranges from 0 to 30. The "CURRENT A (dB)" and "CURRENT B (dB)" sliders range from -20 to 0. The copyright notice "Copyright Ampetronic © 2018-2019" is visible at the very bottom.

The title of the web page is always CX-XX where Xs are dependent on the driver type. At the bottom of the screen are the meters for the level of compression and the current in loop A (and B if present).

It should be noted that the settings displayed on the Audio Settings tab of the web page are updated once a second. Thus if someone changes a value from the front panel or via another web connection, these changes will be shown on the web page as they happen.

## Audio Settings Tab

The audio settings tab allows control of the most important settings of the driver. The items on this page are sliders and drop down boxes. In order that the slider settings cannot be changed by a large amount accidentally, the clicking on a slider track to set a value is disabled.

To alter a value it is necessary to click on the slider handle and move it. The value is not sent to the driver until the slider handle is released (mouse click up or finger off touchscreen). Alternatively it is possible to click in the text box next to the slider and enter a value directly.

There are two important points to note about directly entering values into the text box.

- Although the slider will move as the value is altered, no information is sent to the driver as this happens.
- The value only gets sent to the driver when the edited slider “loses focus” which means that you have to click (or touch if on a mobile device) at a point somewhere away from the slider you have just adjusted. Only at this point is the new value transferred to the driver.

There are 13 adjustable parameters on the audio settings page:

|  |   |
|--|---|
| <b>Input 1 Low cut filter:</b>                         | Allows a fixed 250Hz low cut filter to be applied for applications where microphones are plugged directly into the input.   |
| <b>Input 1 Attenuation (dB):</b>                       | Controls the attenuation of the input 1 channel. Values of 0 to -80dB in 0.1dB steps are allowed.   |
| <b>Input 2 Low cut filter:</b>                         | Allows a fixed 250Hz low cut filter to be applied for applications where microphones are plugged directly into the input.   |
| <b>Input 2 Attenuation (dB):</b>                       | Controls the attenuation of the input 2 channel. Values of 0 to -80dB in 0.1dB steps are allowed.   |
| <b>Signal Type:</b>                                    | Drop down box that selects the test signal from OFF, Pink Noise, Sine Wave, Combi 1K, Combi 1.6K, Combi 2.5K and disable loop outputs   |
| <b>Frequency:</b>                                      | Controls the frequency of the continuous sine wave test signal  |
| <b>Timeout:</b>  | Controls the time which test signals remain on. 10, 30, 60 and 120 (default) minutes are available.   |
| <b>Current:</b>  | Controls the level of current to loops A and B. Maximum current is with the slider at 0 dB and minimum with the slider at -80 dB.   |
| <b>Offset Value:</b><br>(for dual output drivers only) | Controls the offset between loops A and B. Moving the slider to the left reduces loop A by up to 10dB then off. Moving to the right reduces loop B by up to 10 dB then off.   |
| <b>Slope:</b>  | Corrects system frequency response due to metal structures in a building. The drop down box allows the selection of OFF, Custom or a slope of 0.25dB/Octave to 4.00dB/Octave. See Technical Specifications in section 15 for further details. |

- Custom LF:** A slider that controls the slope of the LF section of the custom MLC. Values of between 0 and 4 in 0.1 dB steps can be entered here.
- Custom Knee:** Controls the frequency where the LF custom slope stops and the HF slope starts.
- Custom HF:** A slider that controls the slope of the HF section of the custom MLC. Values of between 0 and 4 in 0.1 dB steps can be entered here.
- 90° Shift:** This is a switch box with OFF and ON options. ON places a 90 degree phase shift on the current between loops A and B.  
(for dual output drivers only)
- Sleep Mode:** Sleep mode is a low power state which is applied after a user configurable period with no audio signal and no user intervention. Normal conditions are restored on application of an audio signal or user intervention. The setting options are Off, 10 or 60 mins.  
(after no signal)
- Standby:** Standby is a low power state set by switching the control to on. Only switching to off (or user operation of the front panel controls) can return the driver to normal operation

## Network ConfigTab

The network config tab allows you to configure the Ethernet settings used by the driver. You can also configure the driver to send an Email when a power cycle or error condition occurs or regularly on a timed basis.

Finally you can use this tab to save the settings of the driver to an XML file on your device and load a settings XML file in order to set the driver to a known configuration.

The screenshot shows the 'Network Config' tab of the C7-2N Hearing Loop Driver interface. The interface is organized into several sections:

- Ethernet Configuration:** Includes fields for MAC Address (30 DA 60 A0 90 16), Driver Name (C7-2N), and a DHCP toggle set to 'On'. A warning message states: "Incorrect settings may cause the driver to lose network connectivity. If a network connection cannot be obtained after changes, you will need to restore configuration using the USB port. On pressing 'Save Ethernet Configuration and Restart', the driver will restart to implement the new Ethernet settings. Other unsaved changes will be lost." A 'Save Ethernet Config and Restart' button is at the bottom.
- Status Reporting:** Includes a 'Reporting Email Address' field with an 'Update Email' button, a 'Power Cycle Logging' toggle set to 'On', an 'Email Error Reports' toggle set to 'Off', a 'Status Report Interval' dropdown set to 'Off', and a '12V DC Out' dropdown set to 'DC on'. A note says: "Email changes are effective immediately and do not require a restart."
- Control Protocol Selection:** Includes a 'Telnet' toggle set to 'On'. A note says: "A restart is required after enabling or disabling Telnet."
- Firmware Upgrades:** Includes a link to 'Firmware Upgrades'.
- Save and Restore Configuration:** Includes a 'Save Configuration' button, a 'Choose file' field with a 'Choose file' button and 'No file chosen' text, and a 'Restore configuration' button.
- Restart Driver:** Includes a 'Restart' button. A note says: "On pressing 'Restart', any unsaved changes will be lost and the driver will restart. This will activate any saved changes which also require a restart."

At the bottom of the interface, there is a status bar with the following indicators:

|                  |     |     |     |     |     |     |     |     |     |     |     |     |     |     |     |     |
|------------------|-----|-----|-----|-----|-----|-----|-----|-----|-----|-----|-----|-----|-----|-----|-----|-----|
| COMPRESSION (dB) | 0   | 10  | 20  | 30  | 40  | 50  | 60  | 70  | 80  | 90  | 100 | 110 | 120 | 130 | 140 | 150 |
| CURRENT A (dB)   | -10 | -15 | -20 | -25 | -30 | -35 | -40 | -45 | -50 | -55 | -60 | -65 | -70 | -75 | -80 | -85 |
| CURRENT B (dB)   | -10 | -15 | -20 | -25 | -30 | -35 | -40 | -45 | -50 | -55 | -60 | -65 | -70 | -75 | -80 | -85 |

Copyright Amptronic © 2018-2019

|  |   |
|--|---|
| <b>MAC Address:</b>                      | Media Access Control (MAC) address. This is a unique number that all Ethernet connected devices require. This field is read only.   |
| <b>Driver Name:</b>                      | The name of the driver shown on the LCD, in the Email reports and on the web page heading.  |
| <b>DHCP:</b>                             | Dynamic Host Configuration Protocol (DHCP). Turn this on to allow the driver to get all the network configuration fields from the DHCP server on the network when it starts up. |
| <b>IP Address:</b>                       | This is the IP address that the driver is currently using. Edit this only if DHCP is disabled otherwise the DHCP will override the entered value.                               |
| <b>Gateway:</b>                          | The IP address of the Gateway used for routing communication outside of the local network.  |
| <b>Subnet Mask:</b>                      | The Subnet Mask which defines the scope of the local IP range to be used.   |
| <b>Primary DNS:</b>                      | The IP address of the primary domain name server to be used to resolve IP addresses.  |
| <b>Secondary DNS:</b>                    | The IP address of the secondary domain name server if the first is not contactable.   |
| <b>Save Ethernet Config and Restart:</b> | Press this button if you have changed any of the network parameters. It will save the settings and restart the driver to utilise the new configuration.                         |

## Status Reporting

Use this section to enable and configure the Email reporting features of the driver.

|                                 |  |
|---------------------------------|--|
| <b>Reporting Email Address:</b> | The Email address of the person who needs to receive status emails from the driver unit.   |
| <b>Power Cycle Logging:</b>     | The driver sends an Email every time the software restarts. This can be caused by a power cycle, a user reset request or a software error. |
| <b>Email Error Reports:</b>     | This causes the driver to send an Email whenever an error occurs   |
| <b>Status Report Interval:</b>  | This causes an Email to be sent on a regular interval basis.   |
| <b>12V DC Out:</b>              | Allows the DC output on the back of the amplifier to be turned off, on or automatically controlled to reflect amplifier status.            |

## Control Protocol Selection

|                |                                      |
|----------------|--------------------------------------|
| <b>Telnet:</b> | Enables or disables Telnet protocol. |
|----------------|--------------------------------------|

|                           |  |
|---------------------------|--|
| <b>Firmware Upgrades:</b> | When connected to the Internet clicking this control takes you to a web page showing currently available upgrades. |
|---------------------------|--|

## Save and Restore Configuration

This section allows the complete configuration of the driver, to be saved to an XML file on the browsing device. This XML file can then be loaded into a driver which will set the parameters up exactly as the unit from which the configuration file was saved.

Click on this link and save to a location on your device: Click on “Save Config”. This will bring up a dialogue box for you to save the file.

**Choose File:** Clicking this button will allow you to navigate to the location of the XML file that you want to load into the driver.

## Status Tab

The status config tab allows you to see the status of the driver.

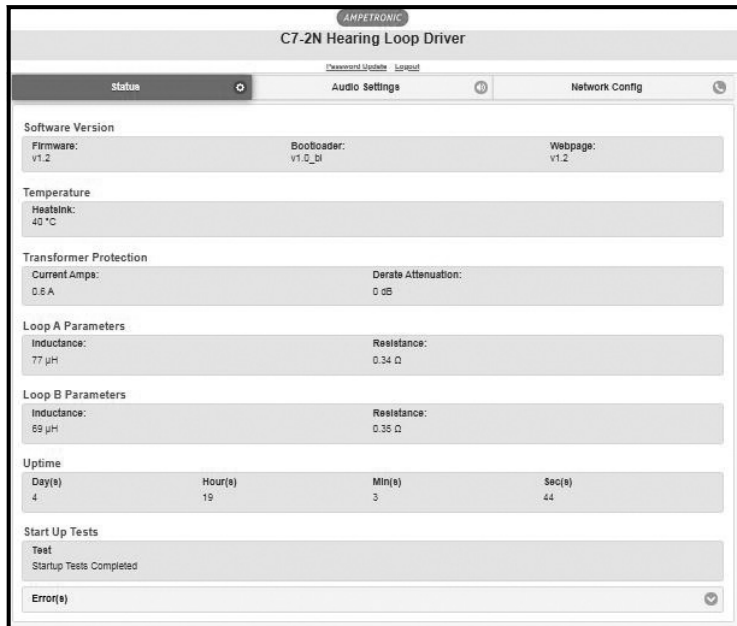

**Software Version:** The version of the bootloader, the firmware in the driver and the version of the website. In order to update firmware, please refer to Section 13.

**Temperature:** This is the temperature of the driver’s internal heatsink. If it exceeds 75°C the driver current will be reduced. If it exceeds 85°C the driver will be muted.

**Current Amps:** The current being drawn from the transformer. If this exceeds the maximum limit for longer than a defined time then the driver current will be reduced. The amount of additional attenuation will be shown in the derate section.

**Derate Attenuation:** This is the amount of additional attenuation that is added to the current setting when the transformer is overloaded or the heatsink is too hot.

**Loop Parameters:** (A & B shown for dual output drivers) The measured value of the resistance and inductance of the loop circuit when the driver was last restarted or switched on.

**Uptime:** This shows the time since the driver was last restarted or switched on.

**Start Up Tests:** This shows if the driver has stopped on a start-up test failure (the test that failed will be displayed in red) or if the start-up tests all passed (start-up tests completed).

**Error(s):** Either No Error if the driver is running correctly or a list of the error messages in red. See chapter 10 Troubleshooting for a complete description of the error codes, what causes them and how to fix the system to remove them.

## 9. EMAIL NOTIFICATIONS

The driver can be configured to send Emails to a specified address under certain conditions. These Emails contain a list of any errors that are present and the settings of the driver at the time that the Email was sent. A sample Email is shown below:

This is an automatically generated notification Email sent to the contact address configured by the installer/administrator of an Ampetronic Loop Driver. Please do not reply to this Email.  
Your Hearing Loop Driver named C5-2N with MAC address 30:0A:60:A0:52:F1, has either developed a fault or the settings have been modified without authorisation. The amplifier firmware version is v0.15. The amplifier or loop may require attention.  
The configuration page of the amplifier can be reached by clicking this link: C5-2N if you are on the same network domain as the amplifier

The system errors present on the amplifier when this Email was sent are listed below:

-----  
Errors have cleared. No faults at present

-----  
The current settings of the amplifier are listed below:

Input 1 level is -30.0dB  
Input 2 level is -80.0dB  
Current level is -12.0dB  
Current B offset is 0.0dB  
MLC selected is 0  
MLC custom slope 1 is 1.0dB/Oct  
MLC change frequency 1000Hz  
MLC custom slope 2 is 1.0dB/Oct  
The measure loop parameters on channel A are 539mR and 190uH  
The measure loop parameters on channel B are 527mR and 210uH  
The amplifier has been running for 8089 milliseconds since it last rebooted

End of Email

The Email can be sent when the driver is restarted, when an error occurs or periodically to monitor the state of the loop driver. These settings are only controlled through the web interface – there is no menu on the front panel that alters these settings. The controls for the Email system can be found on the Config tab of the web interface. See section 8 Ethernet interface of this manual for further information.



# 10. USING A WIRELESS ROUTER

## Using a wireless router when a network is not available

Using a network connection to set up the C Series drivers from an Ethernet enabled device makes loop commissioning a much quicker and less frustrating process. It is even better if the device is wireless and utilising the Loopworks Measure App and Receiver.

It is quite simple to create a temporary wireless network using a wireless router connected to a C series driver to which your wireless device can then be connected. However, it is necessary to exercise caution before doing this, as a temporary wireless network may interfere with an existing installed network.

The procedure to enable remote access should be:

1. Check whether the IT manager is happy for you to set up a temporary network for configuring the driver. If you get permission, this may be an easier option than connecting to the existing system. See below for instructions on connecting a TP-Link Nano router to the loop driver.
2. If permission is not given, check whether the IT infrastructure is already in place i.e. are there network sockets near the driver that are working? And is there a wireless network that can communicate with those network sockets that covers the area of the loop to be configured? If the answer is yes to both these questions then ask if you can have temporary access to the wireless network to remotely configure the driver. If not, ask if you can plug a laptop into the network to communicate with the loop driver.
3. If a network is available, check whether DHCP is used on it. If it is, enable DHCP on the driver. If DHCP is not used then switch off DHCP in the driver and ask for an IP address from the IT manager. Set the driver IP address manually in the Ethernet menu of the driver.
4. If all the above fail or you are not allowed access to the existing infrastructure, run a CAT-5 Ethernet cable from a laptop to the driver directly (see section 8).

## Using the C Series drivers with the TP-Link Nano Router

The TP-Link Nano Router is a compact and relatively inexpensive wireless router that will allow wireless control of the C Series driver through the web interface. The driver is connected to the router using the CAT-5 Ethernet cable supplied with the router.

A wireless device such as a smartphone, tablet, or a laptop can then be used to access the C-Series driver's web interface.

The factory default values for the C Series driver's Ethernet configuration will work with the TP-Link Nano router default values. Neither device needs special configuration. Please follow the steps below to allow wireless control of your C Series driver.

1. On the back of the TP-Link Nano Router, underneath the MAC barcode, there is an SSID and a Password. The C-Series driver is capable of powering the TP-Link Nano Router via the USB port, provided that the external 12V power socket of the driver is not used. Plug the USB cable into the C-Series Driver but do not yet plug the Ethernet cable into the driver.

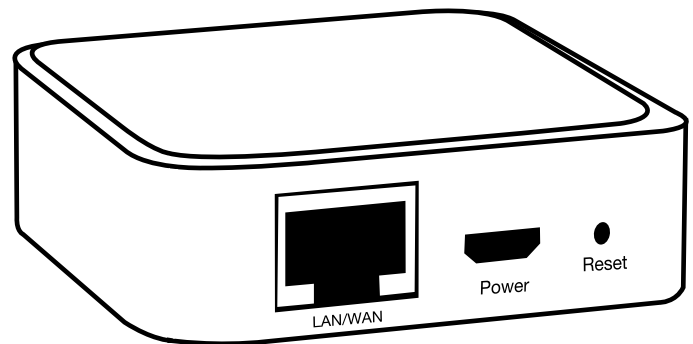

2. On your wireless enabled device, look for the SSID in the list of available wireless networks. Select this SSID and your device will ask for the password. Enter the password on the back of the router.
3. To check that the connection between your device and the TP-Link Nano Router is working, open up a browser window in your device and in the address bar (where you enter a web address such as www.google.com) enter the numbers 192.168.0.254. You should be asked for a username and a password. Enter “admin” for both. You should then see the TP-Link Nano Router control panel screen.
4. Plug in the Ethernet cable from the driver into the TP-Link Nano Router. The driver front panel should display the IP address that the router has assigned to the driver on the LCD display for 5 seconds. If you miss this, the IP address of the driver is available by navigating to the network screen.
5. Now in the address bar of your browser, enter the IP address that you read from the driver. You should see the web interface of the C Series driver.  
**N.B. Login details are in section 8.**

## Wireless Network Troubleshooting

### 1. It was working and I could see the driver interface but now it is frozen.

Some devices test a wireless connection for a route to the internet and automatically change to a different data connection if the internet is not available. Check that the wireless connection is still connected to the TP-Link Nano Router. If all else fails, turn off your mobile data so that your device has to use the TP-Link Nano Router.

### 2. Refresh the web page.

The signal from the Nano Router may be lost as you walk around. Refreshing the page will force your device to reconnect with the Nano Router.

### 3. Try to access the Nano Router Configuration page at 192.168.0.254.

If you cannot access this you will not be able to access the driver.

### 4. I can see the web interface but it responds really slowly.

The C-Series web interface does many tasks a second and older phones struggle to maintain a reasonable update speed. We recommend a multicore Android phone or an iPhone 5 as a minimum level of performance for a good user experience.

### 5. I run out of Wi-Fi range before I have covered all of the area of the loop.

A building with lots of metal in its construction will reduce the Wi-Fi range of the TP-Link Nano Router to less than 25m. Other routers will not have much more range than this as the radio frequency power output has a legal maximum limit.

It is suggested that a long CAT-5 cable is used to connect the driver to the TP-Link Nano Router. The TP-Link Nano Router can then be in the middle of the loop area and the range will nearly always be sufficient for the loop being commissioned. In this case we recommend that the TP-Link Nano Router be powered from a Lithium phone “power pack” that is designed to recharge mobile devices through a USB type ‘A’ socket. The TP-Link Nano router, a suitable power pack and a long CAT-5 cable are available from Ampetronic (order code: D-WIFI)

# 11. Telnet Commands

## Introduction

This document describes the Telnet command format and the commands that the Driver recognises.

The Telnet interface of the Driver is on port 9760. Therefore to make a Telnet connection to an amplifier whose IP address is 10.2.0.144 the Telnet command would be 'Telnet 10.2.0.144 9760'.

The Telnet interface requires the same authentication as the web interface to access relevant commands. To authenticate at the start of a session send the command login=username&password.

## Command Format

The commands break down into two groups – those that set a value in the Driver and those that read a value back.

## Setting Commands

The command is a string followed by "=" and then the value as specified in the table below.

For example, to set the current to -20dB the command is "cur=-20 " is sent. The return command is used to end a command and trigger the interpreter to process the command. This means that space is never used within a command.

The recognised commands are:

| Command       | Function  | Accepted parameters   |
|---------------|---|---|
| <b>login</b>  | Authenticates user level to control amplifier   | username&password   |
| <b>cur</b>    | Sets the current drive level of the Driver  | -80 to 0  |
| <b>curo</b>   | Sets the current offset. -ve means channel B is quieter than channel A and visa versa. Values beyond +/-10 will disable the respective channel. | -11 to +11  |
| <b>inp1</b>   | Set the input 1 gain dB   | -80 to 0  |
| <b>lowcf1</b> | Enables or disables the low cut filter for input 1  | "en" enables, "dis" disables  |
| <b>inp2</b>   | Set the input 2 gain dB   | -80 to 0  |
| <b>lowcf2</b> | Enables or disables the low cut filter for input 2  | "en" enables, "dis" disables  |
| <b>mlc1</b>   | Set the first MLC slope level in dB/Octave  | 0.0 to 4.0  |
| <b>mlcf</b>   | Set the MLC mid frequency in Hz   | 200 to 5000   |
| <b>mlc2</b>   | Set the second MLC slope level in dB/Octave   | 0.0 to 4.0  |
| <b>mlcq</b>   | Use a pre-set MLC response  | 0 to 17   |
| <b>tfrq</b>   | Set the frequency of the test sine wave in Hz   | 100 to 5000   |
| <b>tsts</b>   | Set the test signal used by the amplifier   | "Off"<br>"Combi10"<br>"Combi16"<br>"Combi25"<br>"Pink"<br>"Sine"<br>"LoopDis" |
| <b>phse</b>   | Sets the phase shift mode   | 0 = "no phase shift"<br>1 = "channel B shifted by 90"                         |
| <b>pwlc</b>   | Controls Emails on power cycling  | "true" enables, "false" disables  |
| <b>erlc</b>   | Controls Emails on error conditions   | "true" enables, "false" disables  |
| <b>slp</b>    | Sets how long the driver will wait after no audio signal before going into sleep mode   | "off", "10", "60"   |

| Command        | Function  | Accepted parameters  |
|----------------|---|--|
| <b>stnd</b>    | Puts the driver into standby mode                               | “en” enables, “dis” disables   |
| <b>itlc</b>    | Sets the interval at which status emails are sent by the driver | “off”, “6h”, “12h”, “24h”, “48h”, “4d”, “1w”, “2w”, “4w”                     |
| <b>dco</b>     | Controls status of 12V DC output                                | “on” DC on<br>“off” DC off<br>“onf” DC on if fault<br>“offf” DC off if fault |
| <b>setip</b>   | Set the IP address when DHCP is disabled                        | XXX.XXX.XXX.XXX  |
| <b>setgw</b>   | Set the gateway address when DHCP is disabled                   | XXX.XXX.XXX.XXX  |
| <b>setmask</b> | Set the subnet mask when DHCP is disabled                       | XXX.XXX.XXX.XXX  |
| <b>setdns1</b> | Set the primary DNS address when DHCP is disabled               | XXX.XXX.XXX.XXX  |
| <b>setdns2</b> | Set the secondary DNS address when DHCP is disabled             | XXX.XXX.XXX.XXX  |
| <b>mail</b>    | Set the reporting email address                                 | “mail=email”   |

## Reading Commands

These commands read back data from the Driver. They do not have an equals sign because the commands are to read back data.

| Command | Response   |
|---------|--|
| mac     | MAC address of the unit  |
| ip      | IP address in format XXX.XXX.XXX.XXX   |
| dns1    | Primary DNS address in format XXX.XXX.XXX.XXX  |
| dns2    | Secondary DNS address in format XXX.XXX.XXX.XXX                                      |
| gw      | Gateway address in format XXX.XXX.XXX.XXX  |
| msk     | Subnet mask in format XXX.XXX.XXX.XXX  |
| disA    | Displayed peak current on channel A (full rated current is 1) (Instantaneous value). |
| disB    | Displayed peak current on channel B (full rated current is 1) (Instantaneous value). |
| comp    | Compression level in dB. (Instantaneous value).                                      |
| pwri    | Input current from the transformer in Amps   |
| lpra    | Returns loop A resistance as measured at the last power cycle.                       |
| lpla    | Returns loop A inductance as measured at the last power cycle.                       |
| lprb    | Returns loop B resistance as measured at the last power cycle.                       |
| lplb    | Returns loop B inductance as measured at the last power cycle.                       |
| temp    | Returns the heatsink temperature in Celsius  |
| errs    | Returns a list of currently active errors  |
| id      | Returns driver type  |

## Usage

Please note that the telnet commands are case sensitive and so the exact strings specified above must be used to control the drivers. *Example 1:* Set the current to -4.3dB. “cur=-4.3 “

*Example 2:* Get the mac address of the driver. “mac”

## 12. TROUBLESHOOTING

The web interface and the front panel interface both report errors that occur in the driver or the connected loops. On the front panel the errors are displayed in the status menu whilst they are displayed in the status tab on the web interface. Some errors are detected at start-up only whilst others may occur when the driver is running.

Below is a list of the start-up error messages and their possible causes:

|   |   |
|---|---|
| <b>HEATSINK TOO HOT<br/>PLS SWITCH OFF:</b> | The driver heatsink has reached a critical temperature and the driver must be switched off. |
|---|---|

The following error messages all indicate an error in the internal circuitry of the driver. Please contact Ampetronic technical support if any of these errors are seen quoting the error message text.

**OUT A FUNC TEST HIGH OVERCURRENT**  
**OUT A FUNC TEST LOOPS CROSSWIRED**  
**OUT B FUNC TEST HIGH OVERCURRENT**  
**OUT B FUNC TEST LOOPS CROSSWIRED**

**These error messages indicate a possible error with the loop or the connections to the loop:**

|   |   |
|---|---|
| <b>LOOP A R &lt; 200mR<br/>FIX AND RESTART:</b> | The driver measured < 200mR for the loop A impedance. This is too low for the driver and must be fixed before the driver will finish the start-up diagnostics. Switch off, fix the fault and switch on again. |
|---|---|

|   |                      |
|---|----------------------|
| <b>LOOP B R &lt; 200mR<br/>FIX AND RESTART:</b> | As above for loop B. |
|---|----------------------|

|   |  |
|---|--|
| <b>LOOP A &gt; 10R LOOP<br/>COULD CLIP:</b> | The loop is not open circuit but has a resistance of > 10R. This is too high and the driver will clip on output peaks. This is a warning and the driver will continue after 5 seconds. |
|---|--|

|   |                      |
|---|----------------------|
| <b>LOOP B &gt; 10R LOOP<br/>COULD CLIP:</b> | As above for loop B. |
|---|----------------------|

|                                |   |
|--------------------------------|---|
| <b>CHANNEL A OPEN CIRCUIT:</b> | This message is displayed if the loop is disconnected whilst the driver is operating (e.g. if a carpet fitter cuts the loop). The message is displayed on the front panel for 5 seconds and on the web interface. |
|--------------------------------|---|

|                                |                      |
|--------------------------------|----------------------|
| <b>CHANNEL B OPEN CIRCUIT:</b> | As above for loop B. |
|--------------------------------|----------------------|

**These are information messages and do not indicate an error:**

|                                     |   |
|-------------------------------------|---|
| <b>DIAGNOSTICS<br/>IN PROGRESS:</b> | This message is displayed on the front panel whilst the start-up tests are being performed. |
|-------------------------------------|---|

|  |  |
|--|--|
| <b>New IP Address<br/>XXX.XXX.XXX.XXX:</b> | A new Ethernet address has been assigned to the driver. This can occur when an Ethernet cable is plugged into the driver or the DHCP system re-assigns a new IP address. |
|--|--|

**These messages appear in the status menu when the associated error is present:**

|                               |   |
|-------------------------------|---|
| <b>Power Limit - derated:</b> | The driver is overloaded and the drive current has been reduced                             |
| <b>Loop A open circuit:</b>   | The driver has detected an open circuit on loop A.  |
| <b>Loop B open circuit:</b>   | The driver has detected an open circuit on loop B.  |
| <b>Temp Limit - derated:</b>  | The internal heatsink is too hot and the driver current on both channels has been reduced.  |
| <b>Temp Limit - muted:</b>    | The internal heat sink has reached an unacceptable level and outputs have been turned off.  |
| <b>Channel A Clipping:</b>    | The driver output maximum voltage is being exceeded and the loop A signal is being clipped. |
| <b>Channel B Clipping:</b>    | The driver output maximum voltage is being exceeded and the loop B signal is being clipped. |

**Display Screen not illuminated**

- Check that the status LED. If it flashes green then the unit is either in standby or sleep mode.
- Check fuse continuity. A 20mm fuse is incorporated into the AC POWER inlet. It is necessary to remove the power cord before extracting the fuse holder. Test the continuity of the fuse using a multimeter. A spare fuse is provided in the fuse holder.



Any replacement fuse **MUST** be of the same rating and type as printed on the rear of the unit.

**COMPRESSION Indicators not illuminating**

Check input connections.

Ensure that the input gain levels (INPUT1 or INPUT2) are set to the appropriate level(s). Check there is sufficient signal level for the required input.

**CURRENT Indicators not illuminating**

There are many possible causes for this:

- Check the COMPRESSION Indicators are illuminating.
- Check that the CURRENT levels are set appropriately.
- Ensure the STATUS LED is not flashing.
- Check that the loop cables are connected, terminated correctly and inserted into the LOOP OUTPUT sockets.
- Check the loops are not open circuit, short circuit, or connected to earth (see instability or high frequency noise section of Troubleshooting)
- Switch the unit off and turn back on.

## **CLIP Indicators illuminated**

Indicates that the output voltage limit has been exceeded and the unit is clipping. Occasional lighting of this indicator on peaks of the signal is not a cause for concern.

- Turn down the CURRENT control on the channel(s) in question to avoid causing the output voltage to clip.
- Check the loop is not open circuit, short circuit, or connected to earth (see instability or high frequency noise section of Troubleshooting)
- Check the loop resistance is within specified limits.

## **Low magnetic field strength**

Due to insufficient CURRENT or excessive metal loss. A special loop design may be required to achieve acceptable performance. Contact Ampetronic for advice.

## **Instability or high frequency noise**

1. It is possible for the loop cables to be grounded under fault conditions, resulting in instability which may sound like high frequency noise, buzz or whistling. The results of this type of fault are unpredictable and may appear as any combination of the front panel indication errors
2. This fault is easy to determine. Simply unplug the loop cables from the amplifier and test with a resistance meter between either of the loop wires and a good earth point such as a metal radiator. There should be an infinitely high (open circuit) reading. Any reading indicates a failure of the loop cable insulation and you will need to either repair or replace the loop cable.
3. Instability can be caused by using poor quality signal cables, long unbalanced (2-wire) signal runs to the inputs (including elsewhere in the audio system), or by running input cables in close proximity with the loop wire over an appreciable distance (>5m). Loop amplifiers are capable of delivering high currents at audio frequencies. If the loop cables are run close to sensitive signal cables it may be possible to induce a signal back into the input of the amplifier causing feedback. Cable runs and loop wires should be kept well apart from each other. To avoid interference maintain a separation of at least 300mm.
4. Instability can cause the amplifier to run hot and may result in the STATUS LED flashing RED.

## **Interference**

1. Background magnetic fields or interference may be present in any location and are unlikely to be caused by or transmitted by the loop system. Monitor this with a loop receiver (such as an ILR3). If the interference is still present with the loop system switched off, then you need to locate and eliminate the source of the interference before switching the loop system back on.
2. Magnetic fields can induce currents into any low impedance electrical path or loop. Audio or video systems with multiple earths may experience pick up of the loop signal. Check entire sound system for evidence of loop signal (most obvious with a test signal), and trace source of pick up.
3. Under certain circumstances, the loop signal may appear as jagged lines or hum bars on a video picture. This could be due to running video (low impedance unbalanced 2-wire circuit) cables in close proximity to the loop cable, or an earth loop. Separate the loop cables or resolve the earth loop to reduce the effect.
4. Remote (and apparently unconnected) PA systems can sometimes pick up loop signals. This is usually because the loop cable becomes damaged (see point 1 of Instability) or induces signals into the remote system through long unbalanced cables. Always run long audio signal cables as 3-wire balanced circuits and keep away from loop cables.

## **Failed AC power fuse in rear of unit**

Unplug the loop and AC power supply from amplifier, and replace the failed fuse with the spare fuse in AC power input fuse tray.

Reconnect the AC power supply and switch on. If the fuse fails again, return the unit to Ampetronic for evaluation - it may be covered under warranty, which will be invalidated by removing the cover. If the fuse does not fail a 'loop error' may be indicated, but shows that the unit is working correctly. Re-connect the loop and switch the power off then on again to reset loop error.

If the fuse fails when the loop is re-connected to the unit, then the loop could be shorted to electrical mains (and building) earth. This can happen even if no audio signal is present, as the short to earth is likely to cause an instability / oscillation / feedback condition to develop. A loop cable short to earth most commonly occurs where flat copper tape is installed on a metal-clad raised access flooring system. If the insulation on the flat copper tape is abraded (for example by a piece of metal swarf trapped below the copper tape), the conductor could short to the earthed tiles.

**When installing on metal-clad raised access floors, it is advisable to insulate beneath the flat copper tape installation using Ampetronic PWT or similar tape.**

The loop short to earth may only be completed when a person steps on the tape in the affected location, which can create significant difficulties when diagnosing the cause of fuse failure. Contact Ampetronic for further advice if a unit is suffering recurring but untraceable failure of the rear panel fuse.

## **13. UPDATING FIRMWARE & WEB INTERFACE**

Visit [www.ampetronic.co/firmware-upgrades/](http://www.ampetronic.co/firmware-upgrades/) to download the latest firmware file and for update instructions. N.B. If updating either the driver firmware or web interface you must ensure both are on the latest version to maintain compatibility.

## **14. ACCESSORIES**

Copper tapes:

- 1.0mm<sup>2</sup> (10mm wide / 0.1mm thick),
- 1.8mm<sup>2</sup> (18mm wide / 0.1mm thick)
- 3.0mm<sup>2</sup> (20mm wide / 0.15mm thick)

Printed Warning Tape

Direct Burial Cable

WiFi Kit (Nano Router, Battery, USB cable, Ethernet cable)

Details of all products and services provided by Ampetronic can be found at [www.ampetronic.co](http://www.ampetronic.co)



# 15. TECHNICAL SPECIFICATIONS to IEC 62489-1 Standard

## Inputs

**Power:** 35/55/95W 230V AC nominal, 45-65Hz [120V option available]

| <b>Fuse values</b> | <b>120V</b> | <b>230V</b> |
|--------------------|-------------|-------------|
| <b>C5-1</b>        | T630mAL     | T315mAL     |
| <b>C5-2</b>        | T1AL        | T500mAL     |
| <b>C7-1</b>        | T1AL        | T500mAL     |
| <b>C7-2</b>        | T1.6AL      | T1AL        |

**Input 1 & 2** 3 way 3.5mm euroblock screw terminal input (supplied) with microphone and line via rear panel switch. Switchable 250Hz low cut filter (network models only).

**Microphone / Line:** Microphone specification; 200 - 600Ω, sensitivity -67dBu. Selectable 24V phantom power on microphone only  
Line sensitivity -42dBu

**100V Line** 2 way 5mm euroblock screw terminal (supplied)  
100V sensitivity +7dBu

## Outputs

**Loop Output Drive Voltage:** 20V<sub>RMS</sub> (28Vpk) at maximum output current per channel

**Loop Output Drive Current:**

**C5-X** 5A<sub>RMS</sub> (7Apk) up to 60 seconds continuous 1kHz sine wave, peak >7A per channel  
Cont. pink noise 2.3A<sub>RMS</sub> short term peaks >7A per ch.

**C7-X** 7A<sub>RMS</sub> (10Apk) up to 60 seconds continuous 1kHz sine wave, peak >10A per channel  
Cont. pink noise 3.3A<sub>RMS</sub> short term peaks >10A per ch.

**Loop Connectors:** 4 way 5mm euroblock screw terminal (supplied) for each output

**DC Output:** 2 way 3.5mm euroblock screw terminal Re-settable, fuse protected 12V 0.1A. Controllable to reflect amplifier status (network models only).

**Line Output:** 3 way 3.5mm euroblock screw terminal (supplied) post AGC balanced output

## Audio System

**Frequency Response:** 80Hz to 6.5kHz

**Distortion:** THD+N <0.3% 1kHz sine at full current

**Automatic Gain Control:** The AGC is optimised for speech. Dynamic range >36dB

**Metal Loss Correction:** Corrects system frequency response issues due to metal structures in a building. Gain constant at 1kHz, adjustable gain slope from 0 to 4dB per octave in 0.25dB increments. Custom 2 slope MLC allows different slopes and transition frequency to be set via the menu (network models only).  
This does not compensate for signal loss from metal structures which can be significant.

**Phase Shift:** User selectable (network models only) at 0° or 90° between outputs

## Additional Functions

**STATUS:** Tri-colour LED:  
Solid GREEN = normal operation  
Flashing GREEN = sleep or standby mode  
Flashing RED = error  
Flashing AMBER = firmware updating

## PHYSICAL

**Size:** Full width 1U 19" rack mount.  
Width 430mm Depth 190mm Height 44mm

**Mounting Options:** Freestanding  
1U 19" rack mount (brackets fitted as standard)

**Weight:** C5-1: 2.5 kg  
C5-2: 2.8 kg  
C7-1: 2.8 kg  
C7-2: 3.1 kg

**Environment:** IP20 rated; 20 to 90% relative humidity; 0 to 35°C

**Cooling:** Passive

## 16. GLOSSARY OF TERMS

| Term                 | Definition   |
|----------------------|--|
| <b>AFIL</b>          | (Audio Frequency Induction Loop). The specific name for technology used to couple an inductive loop to the telecoil in a hearing aid. Generally shortened to 'Induction Loop' or otherwise known to users simply as a 'Hearing Loop'.  |
| <b>AGC</b>           | 'Automatic gain control' is used to provide continuing adjustments in the receiver's gain in order to maintain a relatively constant output signal.  |
| <b>Clip/Clipping</b> | Clipping is a form of waveform distortion that occurs when an amplifier is overdriven and attempts to deliver an output voltage or current beyond its maximum capability.  |
| <b>Class D</b>       | An electronic, or 'switching' amplifier in which the amplifying devices (transistors, usually MOSFETs) operate as electronic switches, instead of as linear gain devices as in other amplifiers. Generating less heat and offering around up to 60% greater energy efficiency. |
| <b>Current</b>       | The quantity of charge per unit of time, measured in Amperes (Amps, A) flowing from positive to negative. In the case of a loop system, current is proportional to field strength.   |
| <b>dB (Decibels)</b> | A unit used to measure the intensity of a sound or the power level of an electrical signal by comparing it with a given level on a logarithmic scale. Often referred to as loudness.   |
| <b>DHCP</b>          | Dynamic Host Configuration Protocol, a protocol for dynamically assigning IP addresses to devices on a network. Supports a mix of static (reserved) and dynamic IP addresses.  |
| <b>Driver</b>        | A term used to differentiate Hearing Loop amplifiers from loudspeaker amplifiers.  |
| <b>DSP</b>           | Digital Signal Processing (DSP) is the numerical manipulation of digital audio signals intended to produce an adjusted version of the input signal.  |
| <b>Dual Slope</b>    | DSP facility used to define the 'knee' in a frequency response curve. Utilised in hearing loop drivers to address specific metal loss characteristics and restore intelligibility.   |
| <b>Ethernet</b>      | Physical standard for a network to connect a number of electronic devices via network cable, typically to form a local area network.   |
| <b>Gain</b>          | Defined as the ratio of the signal amplitude or power at the output port to the amplitude or power at the input port. It is often expressed using the logarithmic decibel (dB) units ("dB gain").  |
| <b>Gateway</b>       | A network device used to route communication outside of the local network. A gateway is typically a router.  |
| <b>Input</b>         | Signal source such as a microphone or line level input from a television or mixing console.  |
| <b>IP Address</b>    | A unique string of numbers separated by full stops (periods) that identifies each computer using the 'Internet Protocol' to communicate over a TCP/IP network.   |
| <b>LAN</b>           | A local area network (LAN) is a network of computers or network enabled devices that interconnects them within a limited area or building, generally via a central network switch. Multiple LANs can be connected via a router   |

|                            |   |
|----------------------------|---|
| <b>Latency</b>             | A short period of delay, usually measured in milliseconds, between when an audio signal enters and when it emerges from a system.   |
| <b>Line Level</b>          | A nominal voltage (typically specified as +4dBu for professional equipment) used to define a standard for transmission of analogue audio signals between audio equipment. Selectable Mic and Line Level inputs are provided on the rear of the Hearing Loop Driver.   |
| <b>MAC Address</b>         | In a local area network (LAN) or other network, the MAC (Media Access Control) address is your computer's unique hardware number.   |
| <b>Mic</b><br>(Microphone) | An instrument for converting sound waves into electrical energy.<br>Microphone output voltage is significantly lower than for a Line Level signal. Selectable Mic and Line level inputs are provided on the rear of the Hearing Loop Driver.  |
| <b>MLC</b>                 | Metal Loss Compensation (MLC) is a frequency shaping filter that is utilised in Hearing Loop Drivers to restore a flat frequency response to the audio signal, restoring speech intelligibility, when performance has been compromised by metal structures in the installation environment.   |
| <b>Output</b>              | In the case of Hearing Loop Drivers, the Output(s) refer to the connection for the Loop cables (or feeder cables). In the case of the C Series these are 5mm euroblock screw terminal connectors.   |
| <b>Phase Shift</b>         | Exploited in Hearing Loop Drivers to 'shift' the relative phase of the two loop output signals between two loop outputs by 90° in order that two separate inductive loops can be driven with the same signal without causing interference between the magnetic fields produced. Using this method an even magnetic field strength can be created throughout the listening plane (ear height) in large areas or building that utilise metal in their construction. |
| <b>Phantom Power</b>       | A 24V microphone power source that uses the existing microphone connections on the 3.5mm euroblock screw terminal connectors. See IEC 61938.  |
| <b>QoS</b>                 | Quality of Service (QoS) refers to the capability of a network to provide better service to selected network traffic over various technologies, including Frame Relay, Asynchronous Transfer Mode (ATM), Ethernet and 802.1 networks, and IP-routed networks.   |
| <b>Redundancy</b>          | Term used in network audio to provide a secondary, identical, isolated network with the same data as the primary. In the event of a failure in the primary network the secondary network is automatically activated.  |
| <b>Router</b>              | A network device that forwards data packets from one network to another. Based on the address of the destination network in the incoming packet and an internal routing table, the router determines which port (line) to send out the packet. Ports typically connect to Ethernet cables.  |
| <b>Switch</b>              | A network switch is a networking device that connects multiple devices together on a computer network.  |
| <b>Subnet Mask</b>         | Defines the extent of the IP range of the local network.  |
| <b>TCP/IP</b>              | TCP/IP (Transmission Control Protocol/Internet Protocol) is the basic communication language or protocol of the Internet. It can also be used as a communications protocol in a private network (either an intranet or an extranet).  |

- USB** The 'Universal Serial Bus' is an industry standard that defines the cables, connectors and communications protocols used in a bus for connection, communication, and power supply between electronic devices. Utilised in the Hearing Loop Driver to provide power to a LAN Router or for connecting a USB drive to update firmware.
- WAN** A Wide Area Network (WAN) is a network which covers a large geographic distance. In many cases WAN refers to the Internet.

## **17. WARRANTY**

This product carries a five year parts and labour warranty from date of shipment from Ampetronic. To qualify for the five year warranty, the product must be registered at [www.ampetronic.co \(products/warranty\)](http://www.ampetronic.co/products/warranty), without which the warranty will be valid for two years only.

The warranty could be invalidated if the instructions in this handbook are not followed correctly, or if the unit is misused in any way.





